

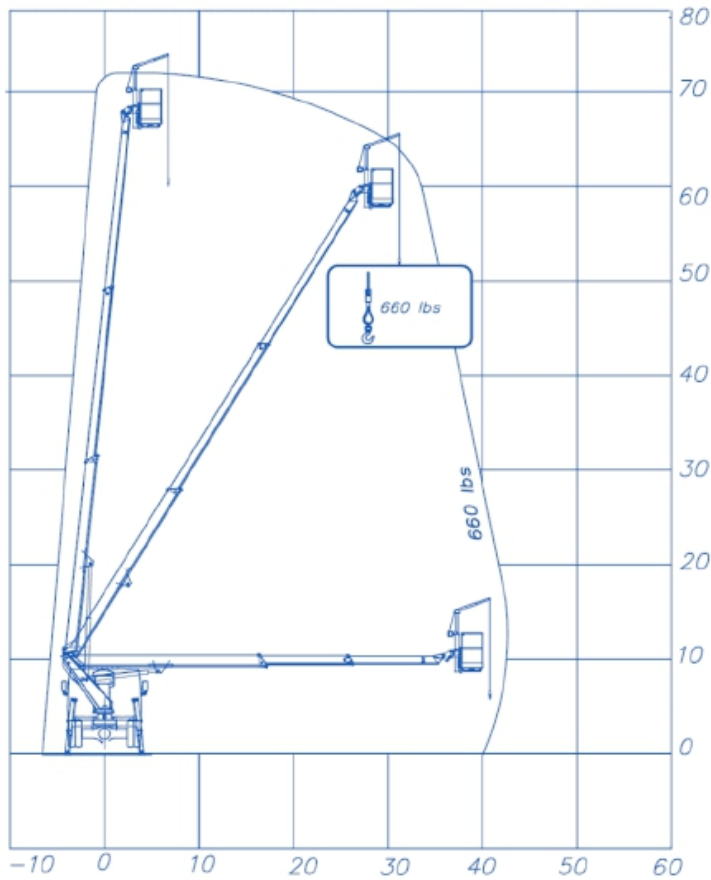



WORKING DIAGRAM





INFO

-  **OUTRIGGERS**
HE+HE

-  **WORKING HEIGHT**
72,00 ft

-  **BASKET HEIGHT**
65 ft

-  **MAX OUTREACH**
43 ft

-  **BASKET LOAD CAPACITY**
1320 lb

-  **BASKET SIZE**
55" X 28" X 43"

-  **BASKET ROTATION**
90° + 90°

-  **CONTROLS**
Electric

-  **TURRET ROTATION**
700°

-  **GVW**
14300 lb

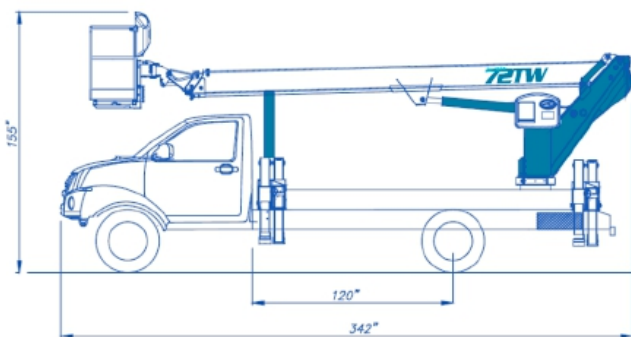

DATA SHEET

Target sector:
Utility & maintenance

Key Features:
Compact dimensions combined with heavy-duty construction-

Ideal for:
Utility pole handling Sign installation General maintenance operations

Dual winch system for maximum versatility:

- 600 lbs basket winch
- 1,800 lbs boom winch

Robust, compact, and reliable — engineered to deliver performance and safety in the most demanding job sites.